

# Molteni & C

## PAUL — VINCENT VAN DUYSSEN 2016

1—  
7



Paul is a set of elegantly proportioned sofas with reassuring lines, elements that emphasize Vincent Van Duysen's expressive rationality. The project includes linear sofas, angular compositions, chaises longues and islands, all with a single seat cushion. Paul features generous dimensions, distinctive double seams and great comfort, elements that look good, even in the center of the room. The impression is lightweight, accentuated by the neat design of the pressure die-cast aluminum feet. Items featuring considerable depth complete the project, for a comfortable, luxurious and cosy way of sitting.

### DATASHEET

REGISTERED  
DESIGN

IX.2018

## FINISHES

### COVERS

fabric - leather, completely removable.

### BASE FINISH

pewter colour  
black chrome painted  
shiny aluminium

Available in fire-resistant version (TB117 and BS5852).

# Molteni & C

## TECHNICAL INFORMATION

### STRUCTURE INTERIOR

Frame made of solid Fir (Picea abies) and chipboard, with elastic straps.

### STRUCTURE PADDING

High capacity variable density foam polyurethane. Light velvet cover.

### SEAT CUSHION

Insert in shaped polyurethane and sterilised feathers. 100% cotton cover.

### BACK CUSHIONS

Polyester fibre, sterilised feathers. 100% cotton cover.

### FEET

In die cast metal with non-slip plastic tips.

### REMOVABLE OUTER COVER

(See attached card, specifically for the cover).

2—  
7

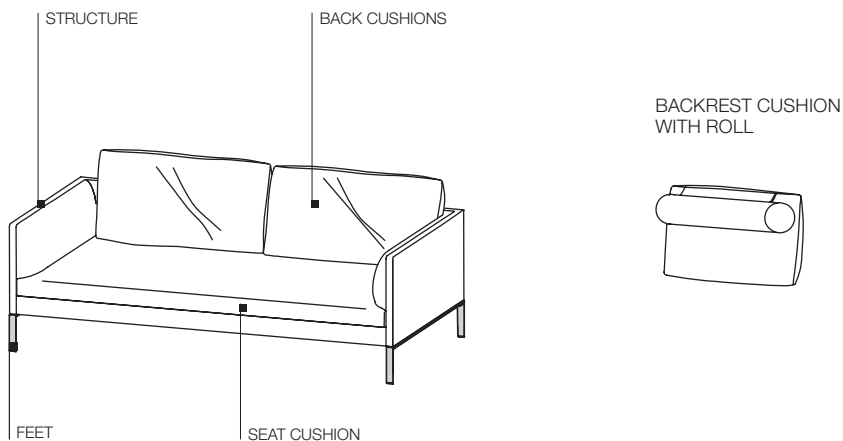

## DATASHEET

REGISTERED  
DESIGN

IX.2018

### Notes

- At the time of ordering, specify the typology of the backrests (with or without the roller).  
If backrests with rollers are selected, specify the quantity.

- It is possible to combine sofas with different depths.

- At the time of ordering, it is possible to choose between two types of seat cushions: STANDARD or SOLID (more rigid).  
If no specifications are indicated, the STANDARD type will be confirmed.

### EXAMPLE OF COMPOSITIONS

Molteni & C

3—  
7

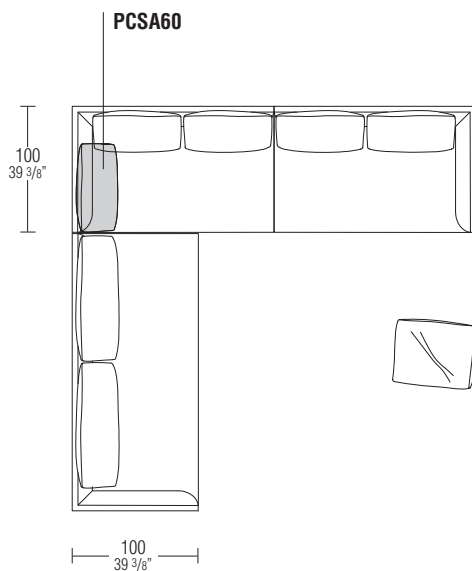

#### Attention:

in compositions with corner  
please add a corner cushion:  
for elements with D 100 **cod. PCSA60**  
for elements with D 120 **cod. PCSA80**

Corner cushions can also be fitted with headrest  
rollers

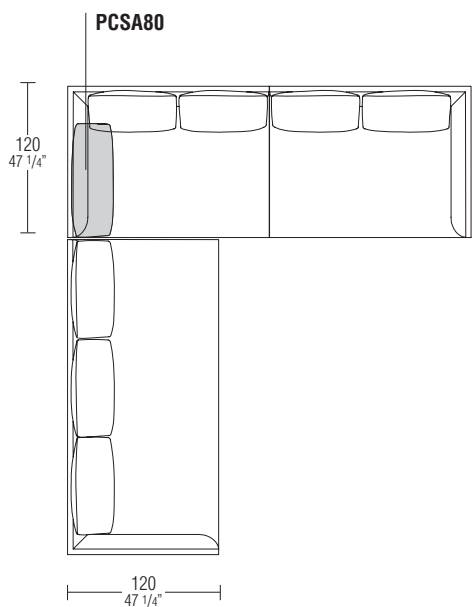

### DATASHEET

REGISTERED  
DESIGN

IX.2018

**DIMENSIONS**

**Paul depth 100**



backrest cushions W 65

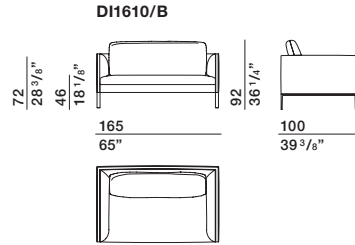

backrest cushion W 100

**ornamental  
cushion  
PCU90/75**

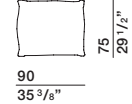

**for adding the  
headrest roller  
to the backrest  
cushion**

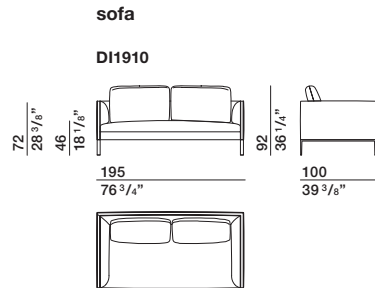

backrest cushions W 80

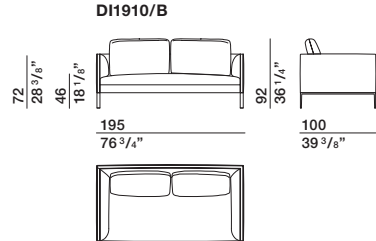

backrest cushions W 65

**ornamental  
cushion  
PCU90/75**

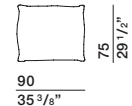

**for adding the  
headrest roller  
to the backrest  
cushion**

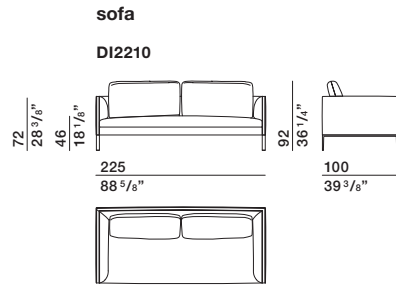

backrest cushions W 95

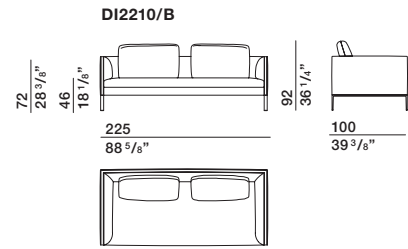

backrest cushions W 80

**ornamental  
cushion  
PCU90/75**

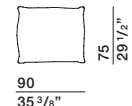

**for adding the  
headrest roller  
to the backrest  
cushion**

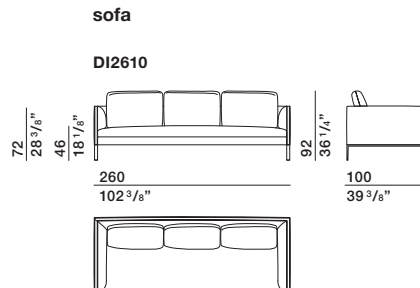

backrest cushions W 75

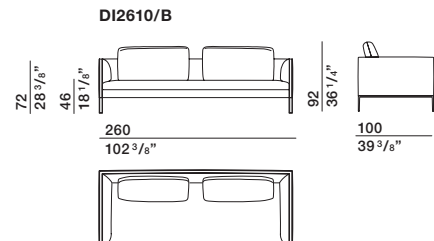

backrest cushions W 95

**ornamental  
cushion  
PCU90/75**

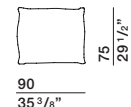

**for adding the  
headrest roller  
to the backrest  
cushion**



**DATASHEET**

REGISTERED  
DESIGN

IX.2018

**DIMENSIONS**

**Paul depth 100**

Molteni & C

5—  
7

**end element**

**TE1610 dx - sx**

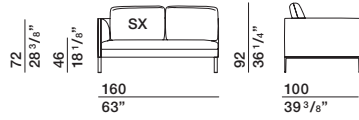

160  
63"

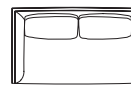

backrest cushions W 70

**TE1610/B dx - sx**

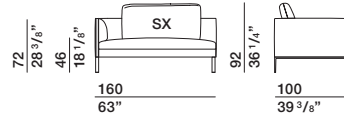

160  
63"

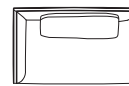

backrest cushion W 100

**ornamental  
cushion  
PCU90/75**

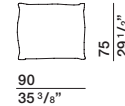

**for adding the  
headrest roller  
to the backrest  
cushion**



**end element**

**TE1910 dx - sx**



190  
74 3/4"



backrest cushions W 85

**TE1910/B dx - sx**

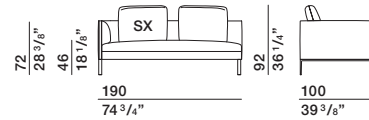

190  
74 3/4"

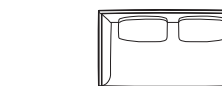

backrest cushions W 65

**ornamental  
cushion  
PCU90/75**

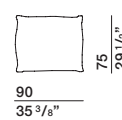

**for adding the  
headrest roller  
to the backrest  
cushion**



**end element**

**TE2210 dx - sx**

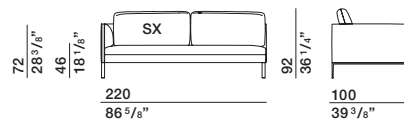

220  
86 5/8"



backrest cushions W 100

**TE2210/B dx - sx**

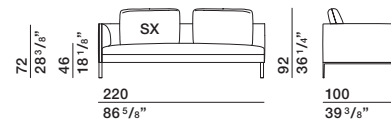

220  
86 5/8"

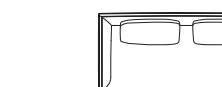

backrest cushions W 80

**ornamental  
cushion  
PCU90/75**

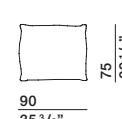

**for adding the  
headrest roller  
to the backrest  
cushion**



**end element**

**TE2510 dx - sx**

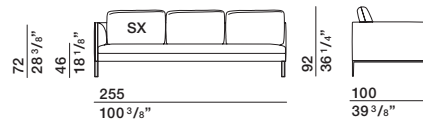

255  
100 3/8"



backrest cushions W 80

**TE2510/B dx - sx**

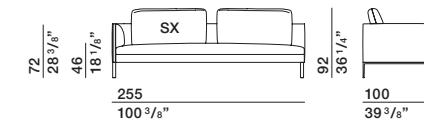

255  
100 3/8"



backrest cushions W 95

**ornamental  
cushion  
PCU90/75**

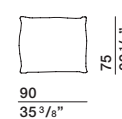

**for adding the  
headrest roller  
to the backrest  
cushion**



**DATASHEET**

REGISTERED  
DESIGN

IX.2018

**DIMENSIONS**

**Paul** common elements

Molteni & C

6—  
7

**island element**  
**IS1510 dx - sx**

72  
28 3/8"  
46  
18 1/8"

156  
61 1/4"

92  
36 1/4"

100  
39 3/8"

**for adding the headrest roller to the backrest cushion**

backrest cushions W 80

**chaise longue**  
**CL1610 dx - sx**

72  
28 3/8"  
46  
18 1/8"

160  
63"

92  
36 1/4"

100  
39 3/8"

**ornamental cushion PCU90/75**

90  
35 3/8"

75  
29 1/2"

**for adding the headrest roller to the backrest cushion**

backrest cushion W 80

**chaise longue**  
**CL2210 dx - sx**

72  
28 3/8"  
46  
18 1/8"

220  
86 5/8"

92  
36 1/4"

100  
39 3/8"

**CL2210/B dx - sx**

72  
28 3/8"  
46  
18 1/8"

220  
86 5/8"

92  
36 1/4"

100  
39 3/8"

**ornamental cushion PCU90/75**

90  
35 3/8"

75  
29 1/2"

**for adding the headrest roller to the backrest cushion**

backrest cushion W 80

backrest cushion W 80

**Paul depth 120**

**sofa**  
**DI2712**

72  
28 3/8"  
46  
18 1/8"

275  
108 1/4"

92  
36 1/4"

120  
47 1/4"

**DI2712/B**

72  
28 3/8"  
46  
18 1/8"

275  
108 1/4"

92  
36 1/4"

120  
47 1/4"

**ornamental cushion PCU90/75**

90  
35 3/8"

75  
29 1/2"

**for adding the headrest roller to the backrest cushion**

backrest cushions W 80

backrest cushions W 95

**DIMENSIONS**

**Paul depth 120**

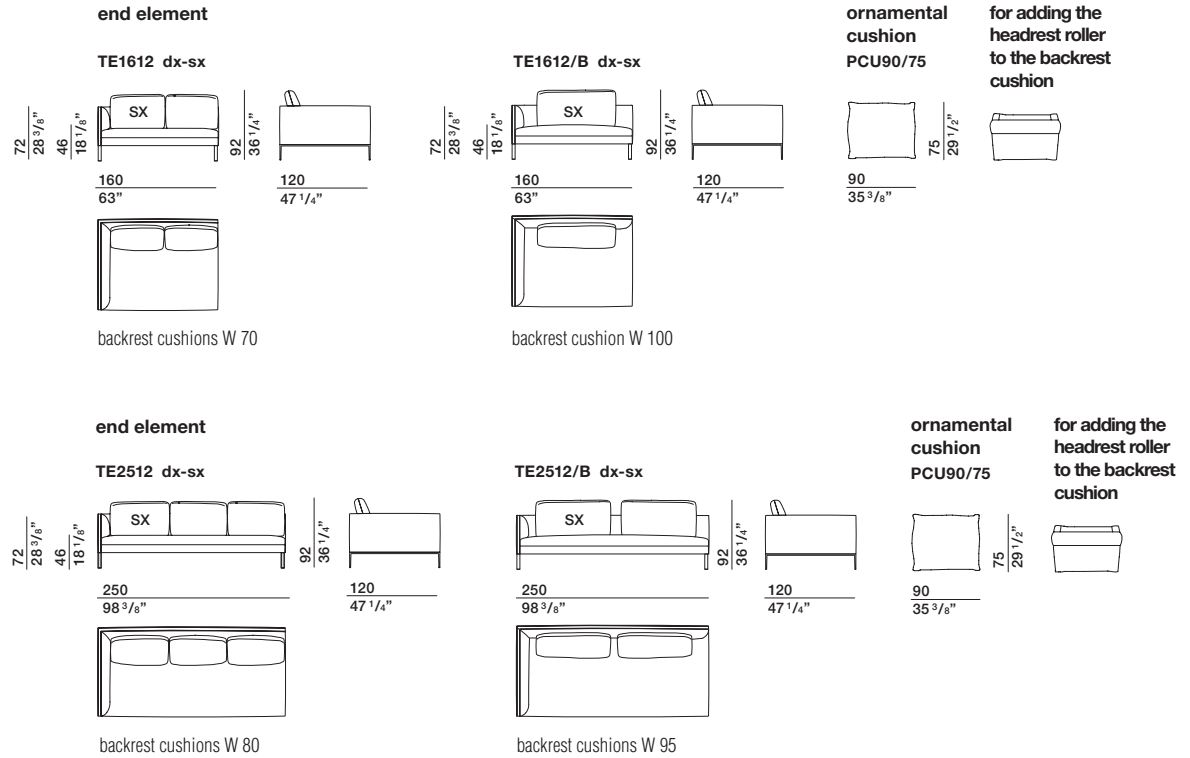

**Paul common elements**

