



ROMP

Frame

Houten constructie van beuken regels, mdf panelen, etc. Voorkant is verstevigd met een metalen strip in de constructie geschroefd en verlijmd.

Vering

Metalen no-sag veren

Schuim

Polyether bedekt met 100 grams dacron.

ARMEN

Frame

Metalen gelast frame van buizen. Op het frame zijn enkele rubber strips gemonteerd om de stoffering te kunnen vastmaken.

Schuim

Gevormd schuim HR-schuim met een soortelijk gewicht van 63kg/m³.

ZIT- EN RUGKUSSENS

Er zijn 4 verschillende soorten uitvoeringen te verkrijgen in de OTIS en OTIS XL.

Firm:

Zitkussen

De basis bestaat uit een stevig HR-schuim met een soortelijk gewicht van 40kg/m³. Daarboven is een lekker zacht HR-schuim (50kg/m³) aangebracht in spie-vorm voor een goede knieholte ondersteuning en voorkomt dat men uit de bank „glijdt“.

De bollering bovenop het kussen is gemaakt van een zacht HR-schuim (35kg/m³). Het kussen uit één stuk is overtrokken met 100 grams dacron.

Rugkussen

Het rugkussen bestaat uit 1 stuk gevormd HR-schuim met een soortelijk gewicht van 40kg/m³. Het kussen uit één stuk is overtrokken met 200 grams dacron.

BODY

Frame

Wooden construction of beech rows, MDF boards, etc. The front is reinforced with a metal strip, which was screwed and glued in place.

Suspension

Metal no-sag springs.

Foam

Polyurethane foam, covered with 100gr Dacron.

ARMS

Frame

Metal welded tubular frame. The frame features rubber strips to attach the upholstery.

Foam

Moulded HR foam with a specific gravity of 63kg/m³.

SEAT & BACK CUSHIONS

The OTIS and OTIS XL come in 4 different versions.

Firm:

Seat cushion

The base is made of a sturdy HR foam with a specific gravity of 40kg/m³. This has been topped with a spline (specific weight 50kg/m³) of soft HR foam, fitted at the front for good knee support and to prevent “sliding” off the couch.

The rounded top of the cushion is made of a soft HR foam (35kg/m³) and covered in a single piece of 100gr Dacron.

Back cushion

The back cushions are made of a single piece of moulded HR foam (specific weight 40kg/m³) and covered in a single piece of 200gr Dacron.

RUMPF

Rahmen

Holzkonstruktion aus Buchenbalken, MDF-Paneeelen usw. Frontseite mit einem in der Konstruktion verschraubten und verleimten Metallstreifen verstärkt.

Federung

No-Sag-Metallfedern

Schaum

Polyether, mit 100 g/m² Dacron bedeckt.

ARMAUFLAGEN

Rahmen

Verschweißter Metallrahmen aus Rohren. Am Rahmen sind mehrere Gummistreifen montiert, an denen die Polsterung befestigt wird.

Schaum

HR-Formschaum mit einer Dichte von 63 kg/m³.

SITZ- UND RÜCKENKISSEN

Für OTIS und OTIS XL sind 4 verschiedene Ausführungen erhältlich.

Firm:

Sitzkissen

Die Basis besteht aus einem festen HR-Schaum mit einer Dichte von 40 kg/m³. Darauf wird ein angenehm weicher HR-Schaum (50kg/m³) aangebracht, in Passfederform für eine gute Kniekehlenunterstützung und um zu vermeiden, dass man vom Sofa „rutscht“.

Die Ausbuchtung oben am Kissen wird aus einem weichen HR-Schaum hergestellt (35kg/m³). Das Kissen aus einem Stück wird mit 100 g/m² Dacron überzogen.

Rückenkissen

Das Rückenkissen besteht aus einem Stück HR-Formschaum mit einer Dichte von 40 kg/m³. Das Kissen aus einem Stück wird mit 200 g/m² Dacron überzogen.

Medium:

Zitkussen

De basis bestaat uit een comfortabel HR-schuim met een soortelijk gewicht van 44kg/m³. Daarboven is een lekker zacht HR-schuim (50kg/m³) aangebracht in spievorm voor een goede knieholte ondersteuning en voorkomt dat men uit de bank „glijdt“.

De bollering bovenop het kussen is gemaakt een een superzacht HR-schuim (35kg/m³).

Het gehele kussen is ingepakt in een 300 grams dacron.

Rugkussen

Het rugkussen bestaat uit één stuk gevormd HR-schuim met een soortelijk gewicht van 44kg/m³. Het kussen uit één stuk is overtrokken met 300 grams dacron.

Soft:

Zitkussen

De basis bestaat uit een HR-schuim met een soortgelijk gewicht van 44kg/m³.

Daarboven is een zogenaamd traagschuim aangebracht die je compleet omsluit tijdens het zitten. Dit traagschuim is gesneden in een spievorm voor een goede knieholte ondersteuning en voorkomt dat men uit de bank „glijdt“.

De schuimkern wordt overtrokken met een dikke hoes gevuld met fiberrolletjes en “memory” schuimvlokken (verhouding 30/70%) die vervolgens is afgedekt met een tijk.

Rugkussen

Het rugkussen is gevuld met een combinatie van dacronrolletjes en “memory” schuimvlokken.

De vulling is verdeeld over verschillende compartimenten.

Medium:

Seat cushion

The base is made of comfortable HR foam with a specific gravity of 44kg/m³. This has been topped with a spline (specific weight 50kg/m³) of soft HR foam, fitted at the front for good knee support and to prevent “sliding” off the couch.

The rounded top of the cushion is made of an exceptionally soft HR foam (35kg/m³), and the entire pillow is wrapped in 300gr Dacron.

Back cushion

The back cushions are made of a single piece of moulded HR foam (specific weight 44kg/m³) and covered in a single piece of 300gr Dacron.

Soft:

Seat cushion

The base is made of HR foam with a specific gravity of 44kg/m³. This has been topped with a so-called memory foam that completely encloses you as you sit down. This memory foam has been cut into a wedge shape for good knee support and to prevent “sliding” off the couch. The foam core is topped with a thick cover filled with fibre curls and “memory” foam flakes (30/70% ratio), which is then covered with ticking.

Back cushion

The back cushion is filled with a combination of Dacron flocks and memory foam flakes, divided over different compartments.

Medium:

Sitzkissen

Die Basis besteht aus einem komfortablen HR-Schaum mit einer Dichte von 44 kg/m³. Darauf wird ein angenehm weicher HR-Schaum (50 kg/m³) angebracht, in Passfederform für eine gute Kniekehlenunterstützung und um zu vermeiden, dass man vom Sofa „rutscht“.

Die Ausbuchtung oben am Kissen wird aus einem superweichen HR-Schaum hergestellt (35 g/m³). Das gesamte Kissen wird in Dacron von 300 g/m² eingepackt.

Rückenkissen

Das Rückenkissen besteht aus einem Stück HR-Formschaum mit einer Dichte von 44 kg/m³. Das Kissen aus einem Stück wird mit 300 g/m² Dacron überzogen.

Soft:

Sitzkissen

Die Basis besteht aus einem komfortablen HR-Schaum mit einer Dichte von 44 kg/m³. Darüber wird ein sogenannter Memory Schaum angebracht, der Sie beim Sitzen vollständig umschließt. Dieser Memory Schaum wird in Passfederform geschnitten, für eine gute Kniekehlenunterstützung, und um zu vermeiden, dass man vom Sofa „rutscht“. Der Schaumkern wird mit einem dicken Bezug überzogen, der mit Faserkügelchen und Memory-Schaumflocken (Verhältnis 30/70%) gefüllt und anschließend mit einem Inlett abgedeckt wird.

Rückenkissen

Das Rückenkissen ist mit einer Kombination aus kleinen Dacron-Röllchen und Memory-Schaumflocken gefüllt. Die Füllung wird über verschiedene Kompartimente verteilt.

Extra Soft:

Zitkussen

De basis bestaat uit een HR-schuim met een soortelijk gewicht van 44kg/m³.

Daarboven is een zogenaamd traagschuim aangebracht die je compleet omsluit tijdens het zitten. Dit traagschuim is gesneden in een spie-vorm voor een goede knieholte ondersteuning en voorkomt dat men uit de bank „glijdt“.

De schuimkern wordt overtrokken met een dikke hoes gevuld met 100% ganzen veren (Oekotex standard-100 gecertificeerd) die vervolgens is afgedekt met een tijk.

Rugkussen

Het rugkussen is gevuld met een 100% verendons (Oekotex standard-100 gecertificeerd).

De vulling is verdeeld over verschillende compartimenten.

Extra Soft:

Seat cushion

The base is made of HR foam with a specific gravity of 44kg/m³. This has been topped with a so-called memory foam that completely encloses you as you sit down. This memory foam has been cut into a wedge shape for good knee support and to prevent “sliding” off the couch. The foam core is topped with a thick cover filled with 100% goose feather down (OEKO-TEX® STANDARD 100-certified), which is then covered with ticking.

Back cushion

The back cushion is filled with 100% goose down (OEKO-TEX® STANDARD 100-certified), divided over different compartments.

Extra Soft:

Sitzkissen

Die Basis besteht aus einem komfortablen HR-Schaum mit einer Dichte von 44 kg/m³. Darüber wird ein sogenannter Memory Schaum angebracht, der Sie beim Sitzen vollständig umschließt. Dieser Memory-Schaum wird in Passfederform geschnitten, für eine gute Kniekehlenunterstützung, und um zu vermeiden, dass man vom Sofa „rutscht“. Der Schaumkern wird mit einem dicken Bezug überzogen, der zu 100 % mit Gänsefedern gefüllt ist (Zertifizierung nach Öko Tex Standard 100), und anschließend mit einem Inlett abgedeckt wird.

Rückenkissen

Das Rückenkissen ist zu 100% mit Daunefedern gefüllt (Zertifizierung nach Öko Tex Standard 100). Die Füllung wird über verschiedene Kompartimente verteilt.

POTEN

Aluminium poten in verschillende afwerkingen/kleuren:

- mat zwart gepoedercoat
- titanium
- matnikkel
- champagne
- eigen keuze (selectie ral-kleuren: www.montis.nl/ral)

Houten poten in verschillende afwerkingen:

- notenhout, matgelakt
- eikenhout, matgelakt
- eikenhout, zwart carbon gebeitst
- eikenhout, witgeolied

Zowel de houten en aluminium poten kunnen optioneel 2cm langer worden besteld.

FEET

The aluminium base comes in different finishes/colors:

- matt black, powder-coated
- titanium
- matt nickel
- champagne
- custom (selection RAL colours: www.montis.nl/ral)

The wooden bases comes in different finishes:

- walnut, matt-lacquered
- oak, matt-lacquered
- oak, carbon black stained
- oak, white oiled

Both the wooden and aluminium legs can be ordered to be 2cm taller.

FÜSSE

Aluminium-Füße in unterschiedlichen Beschichtungen/Farben:

- mattschwarz pulverbeschichtet
- Titan
- matt Nickel
- Champagner
- eigene Wahl (Selektion RAL-Farben: www.montis.nl/ral)

Holzfüße in unterschiedlichen Lackierungen:

- Walnussholz, matt lackiert
- Eichenholz, matt lackiert
- Eichenholz, schwarz carbon gebeitst
- Eichenholz, weiß geölt

Sowohl die Holz- als auch die Aluminium-Füße können wahlweise 2 cm länger bestellt werden.

CONSTRUCTIE

Poef en poef-gedeelte Dormeuse

De poef en het poef-gedeelte van de dormeuse is niet voorzien van no-sag veren in de romp en heeft geen valling in de zitkussens. Dit geeft een andere zitcomfort dan bij de zittingen van de verschillende banken.

OTIS EN OTIS XL

De OTIS XL is de lounge-versie van de OTIS.
Het zitgedeelte is 13cm dieper.
De OTIS en de OTIS XL kunnen aan elkaar worden gekoppeld.

HOEKBANK OTIS EN OTIS XL

De hoekbanken van de OTIS en OTIS XL zijn uitsluitend te gebruiken om een hoek-combinatie te creëren en niet bedoeld om als een losse bank te gebruiken.

BRANDVEILIG

De OTIS en OTIS XL banken zijn te verkrijgen in British Standard 5852, part 1 en 2, en CA, TB 117-2013.

CONSTRUCTION

Footstool & footstool section dormeuse

The footstool and footstool section of the dormeuse don't feature no-sag springs in the body, nor does it have a drop in the seat cushions. This makes for a different kind of comfort experience than the seating elements of our various sofas.

OTIS & OTIS XL

The OTIS XL is the lounge version of the OTIS, with a seating area that is 13cm deeper.
The OTIS and the OTIS XL can be linked together as desired.

CORNER SOFAS OTIS & OTIS XL

The Otis and Otis XL corner sofas should be exclusively used to create corner combinations, and are not intended to be used as a standalone sofa.

FIRE-SAFE

The OTIS and OTIS XL sofas are available in British Standard 5852, part 1 and 2, and CA, TB. 117-2013.

KONSTRUKTION

Puff und Puff-Teil Dormeuse

Der Puff und der Puff-Teil der Dormeuse sind nicht mit No-Sag-Federn im Rumpf ausgestattet und die Sitzkissen haben keine Neigung. Das ergibt einen anderen Sitzkomfort als die Sitze der verschiedenen Sofas.

OTIS UND OTIS XL

OTIS XL ist die Lounge-Version der OTIS. Der Sitzbereich ist 13 cm tiefer.
OTIS und OTIS XL können miteinander verbunden werden.

ECKBANK OTIS UND OTIS XL

Die Eckbänke der OTIS und OTIS XL lassen sich ausschließlich zum Kreieren einer Eckkombination verwenden und sind nicht zur Nutzung als separate Sofas vorgesehen.

FEUERFEST

Die OTIS und OTIS XL Sofas sind als British Standard 5852, part 1 und 2, sowie CA, TB 117-2013 erhältlich.

OTIS

Johan van Hengel 2020



OTIS – tobago clay – titanium

OTIS

Johan van Hengel 2020



OTIS – steelcut trio 996 – ral 6012



OTIS – country antrazit – titanium



OTIS

Johan van Hengel 2020



OTIS – panama 60 – titanium

OTIS

Johan van Hengel 2020



OTIS – vita 03 – walnut, matt-lacquered



OTIS – orsetto 01 – oak, matt-lacquered

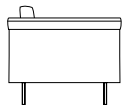

1,5-Z

114,5 cm / 45°

82,5 cm / 32,5°

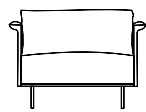

1,5-Z

20 cm / 79°
45 cm / 177°
66 cm / 26°
81 cm / 31,9°

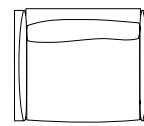

58 cm / 22,8°
88 cm / 34,6°

2-Z

142 cm / 55,9°

110 cm / 43,3°

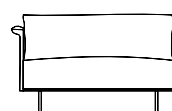

2-Z

20 cm / 79°
45 cm / 177°
66 cm / 26°
81 cm / 31,9°

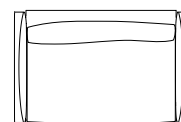

58 cm / 22,8°
88 cm / 34,6°

2,5-Z

169,5 cm / 66,7°

137,5 cm / 54,1°



2,5-Z

20 cm / 79°
45 cm / 177°
66 cm / 26°
81 cm / 31,9°

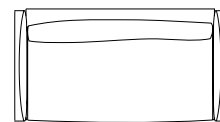

58 cm / 22,8°
88 cm / 34,6°

2,5-Z

169,5 cm / 66,7°

137,5 cm / 54,1°

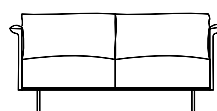

2,5-Z

20 cm / 79°
45 cm / 177°
66 cm / 26°
81 cm / 31,9°

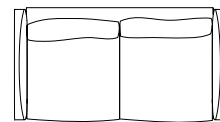

58 cm / 22,8°
88 cm / 34,6°

3-Z

197 cm / 77,5°

165 cm / 65°

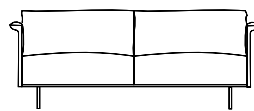

3-Z

20 cm / 79°
45 cm / 177°
66 cm / 26°
81 cm / 31,9°

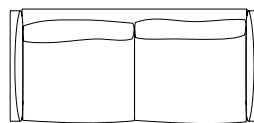

58 cm / 22,8°
88 cm / 34,6°

3,5-Z

224,5 cm / 88,4°

192,5 cm / 75,8°

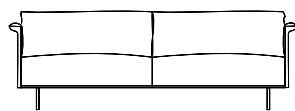

3,5-Z

20 cm / 79°
45 cm / 177°
66 cm / 26°
81 cm / 31,9°

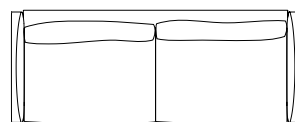

58 cm / 22,8°
88 cm / 34,6°

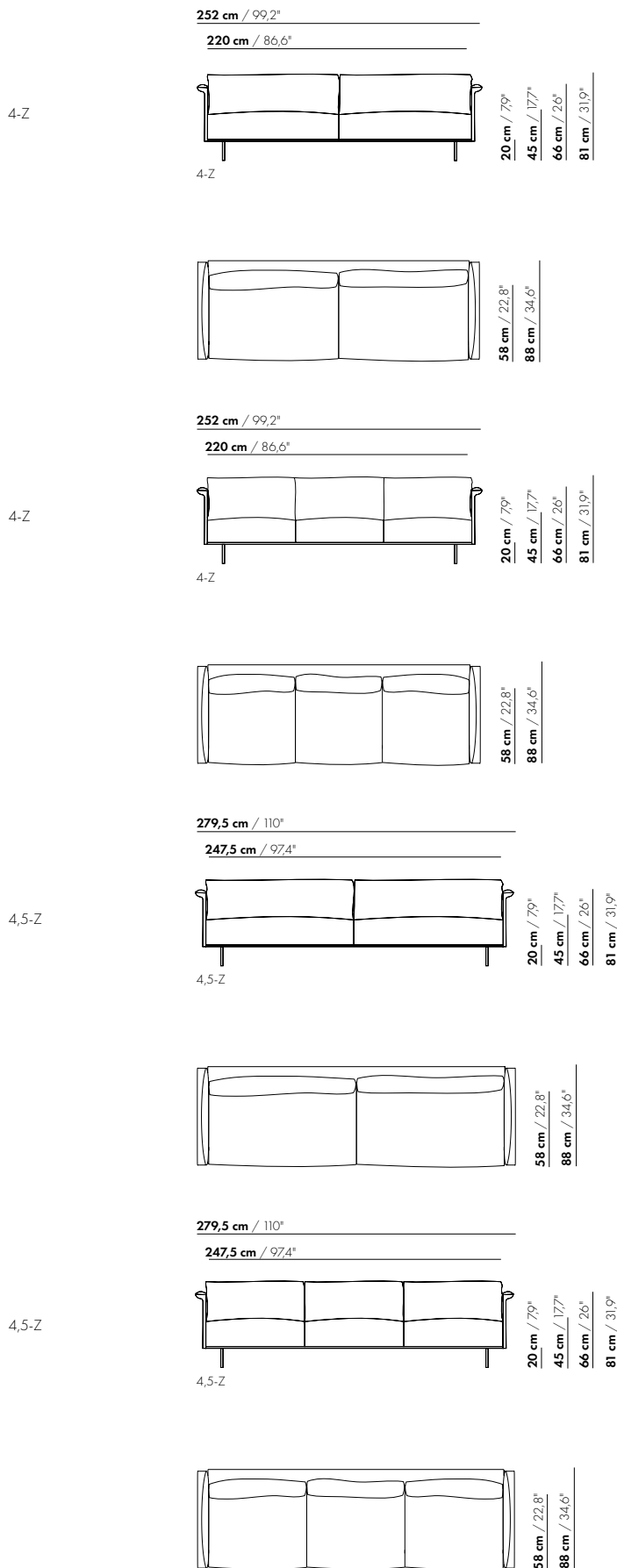

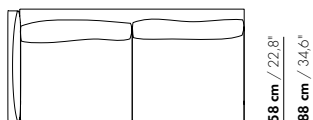
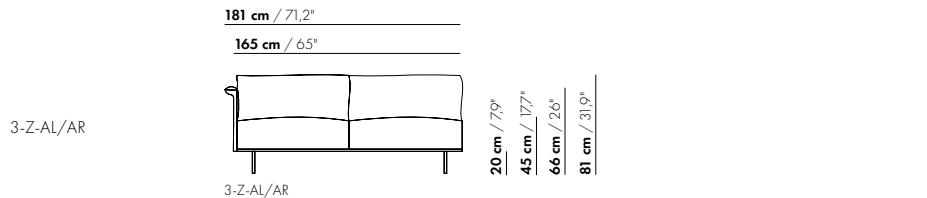
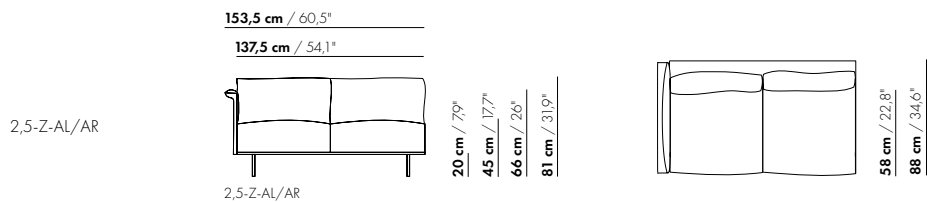
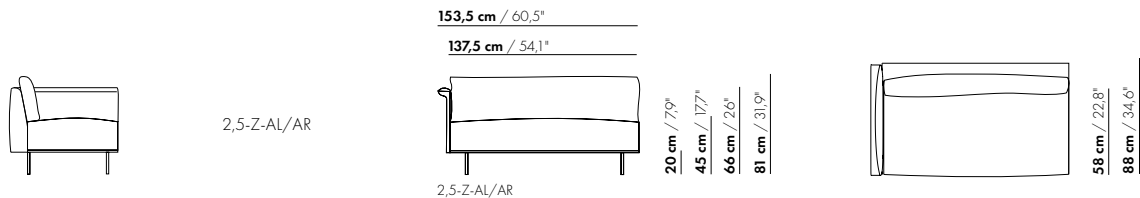
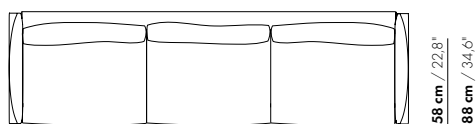
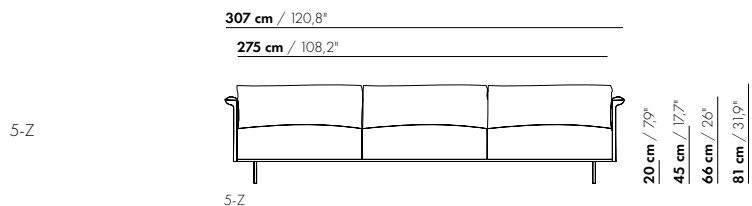
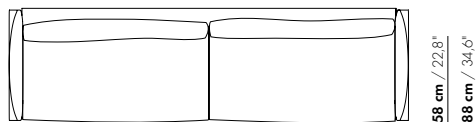
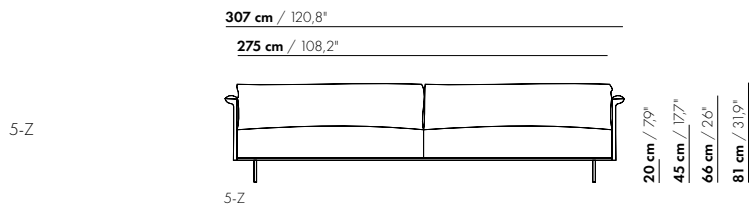

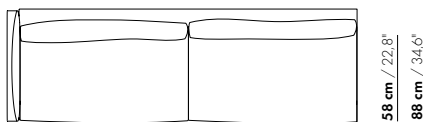
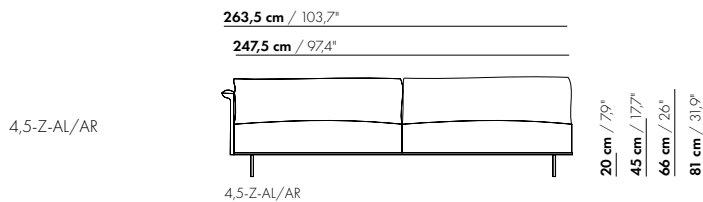
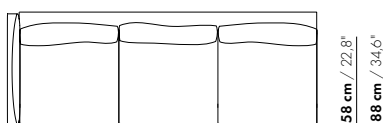
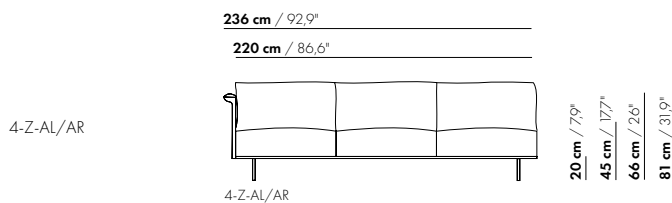
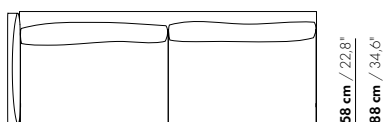
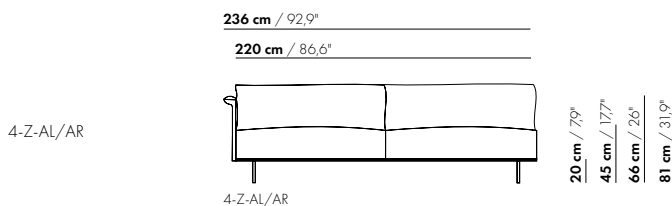
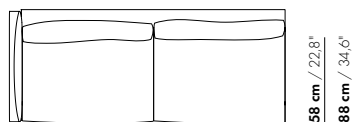
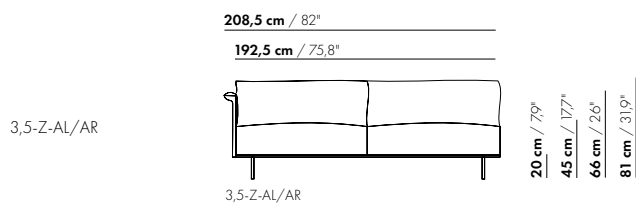

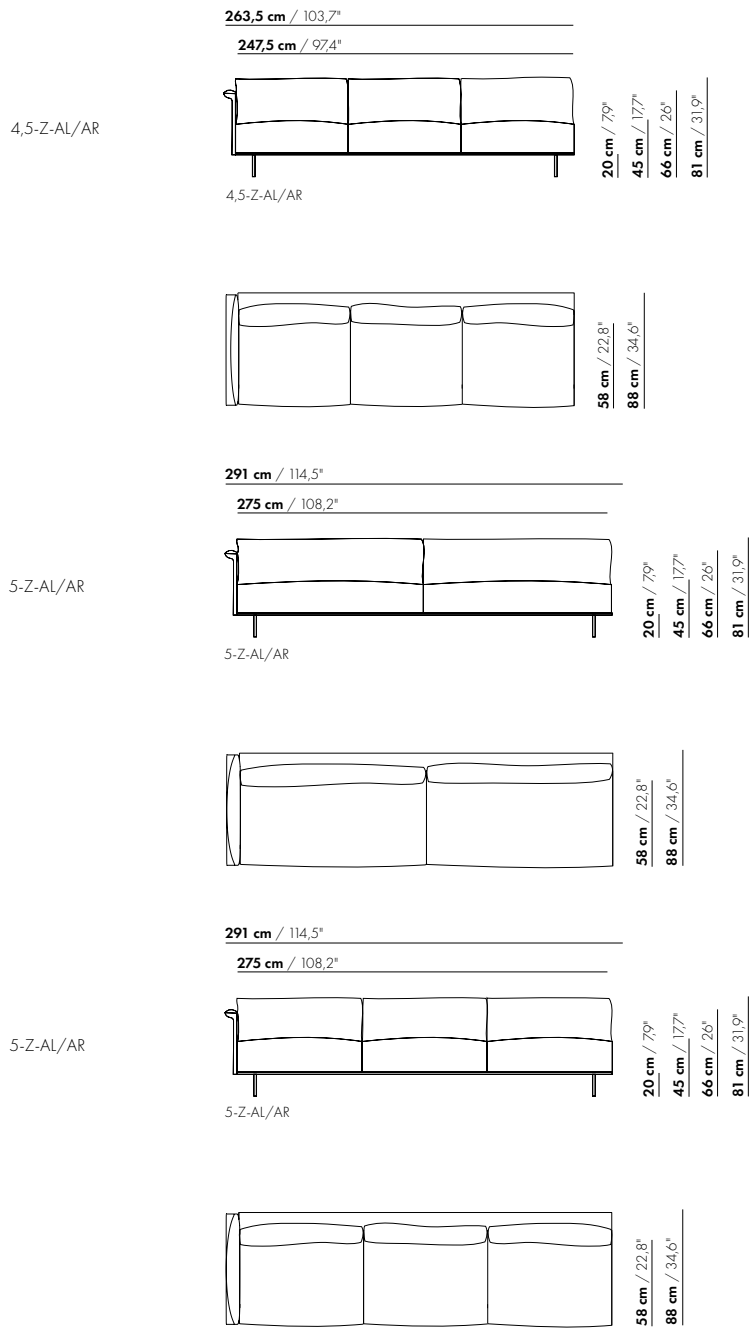

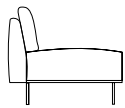

1,5-Z-ZA

82,5 cm / 32,5"

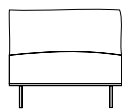

1,5-Z-ZA

20 cm / 7,9"
45 cm / 17,7"
81 cm / 31,9"

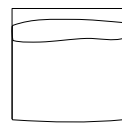

58 cm / 22,8"
88 cm / 34,6"

2-Z-ZA

110 cm / 43,3"

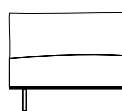

2-Z-ZA

20 cm / 7,9"
45 cm / 17,7"
81 cm / 31,9"

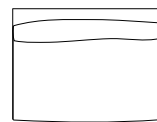

58 cm / 22,8"
88 cm / 34,6"

2,5-Z-ZA

137,5 cm / 54,1"

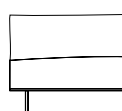

2,5-Z-ZA

20 cm / 7,9"
45 cm / 17,7"
81 cm / 31,9"

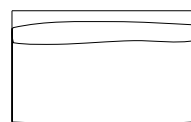

58 cm / 22,8"
88 cm / 34,6"

2,5-Z-ZA

137,5 cm / 54,1"

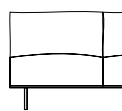

2,5-Z-ZA

20 cm / 7,9"
45 cm / 17,7"
81 cm / 31,9"

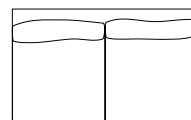

58 cm / 22,8"
88 cm / 34,6"

3-Z-ZA

165 cm / 65"

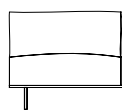

3-Z-ZA

20 cm / 7,9"
45 cm / 17,7"
81 cm / 31,9"

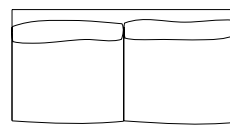

58 cm / 22,8"
88 cm / 34,6"

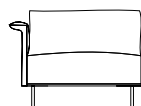

3,5-Z-D-PL/PR

265,5 cm / 104,5"

176,5 cm / 69,5"

55 cm / 21,6"

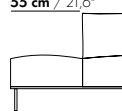

3,5-Z-D-PL/PR

20 cm / 7,9"
45 cm / 17,7"
66 cm / 26"
81 cm / 31,9"

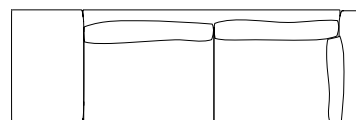

58 cm / 22,8"
88 cm / 34,6"

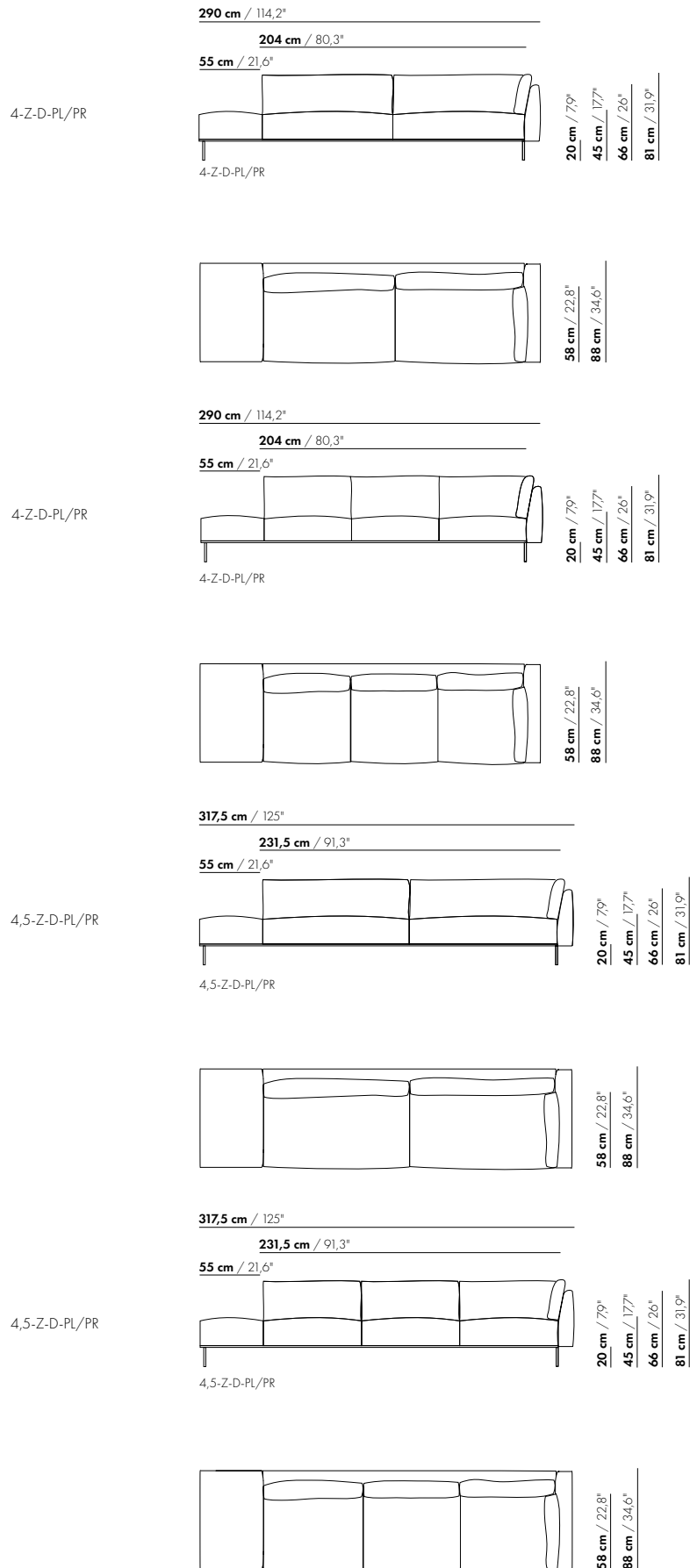

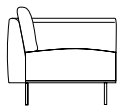

3-Z-H-AL/AR

195 cm / 76,7"

149 cm / 58,6"

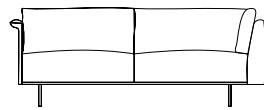

3-Z-H-AL/AR

20 cm / 7,9"

45 cm / 17,7"

66 cm / 26"

81 cm / 31,9"

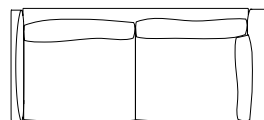

58 cm / 22,8"

88 cm / 34,6"

222,5 cm / 87,6"

176,5 cm / 69,5"

3,5-Z-H-AL/AR

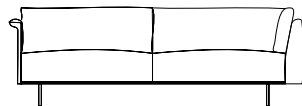

3,5-Z-H-AL/AR

20 cm / 7,9"

45 cm / 17,7"

66 cm / 26"

81 cm / 31,9"

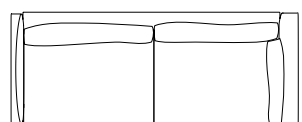

58 cm / 22,8"

88 cm / 34,6"

250 cm / 98,4"

204 cm / 80,3"

4-Z-H-AL/AR

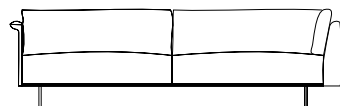

4-Z-H-AL/AR

20 cm / 7,9"

45 cm / 17,7"

66 cm / 26"

81 cm / 31,9"

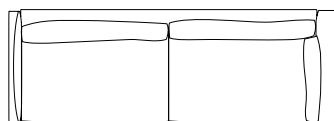

58 cm / 22,8"

88 cm / 34,6"

250 cm / 98,4"

204 cm / 80,3"

4-Z-H-AL/AR

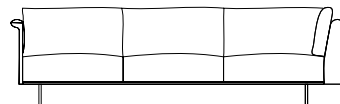

4-Z-H-AL/AR

20 cm / 7,9"

45 cm / 17,7"

66 cm / 26"

81 cm / 31,9"

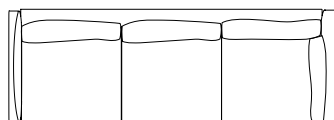

58 cm / 22,8"

88 cm / 34,6"

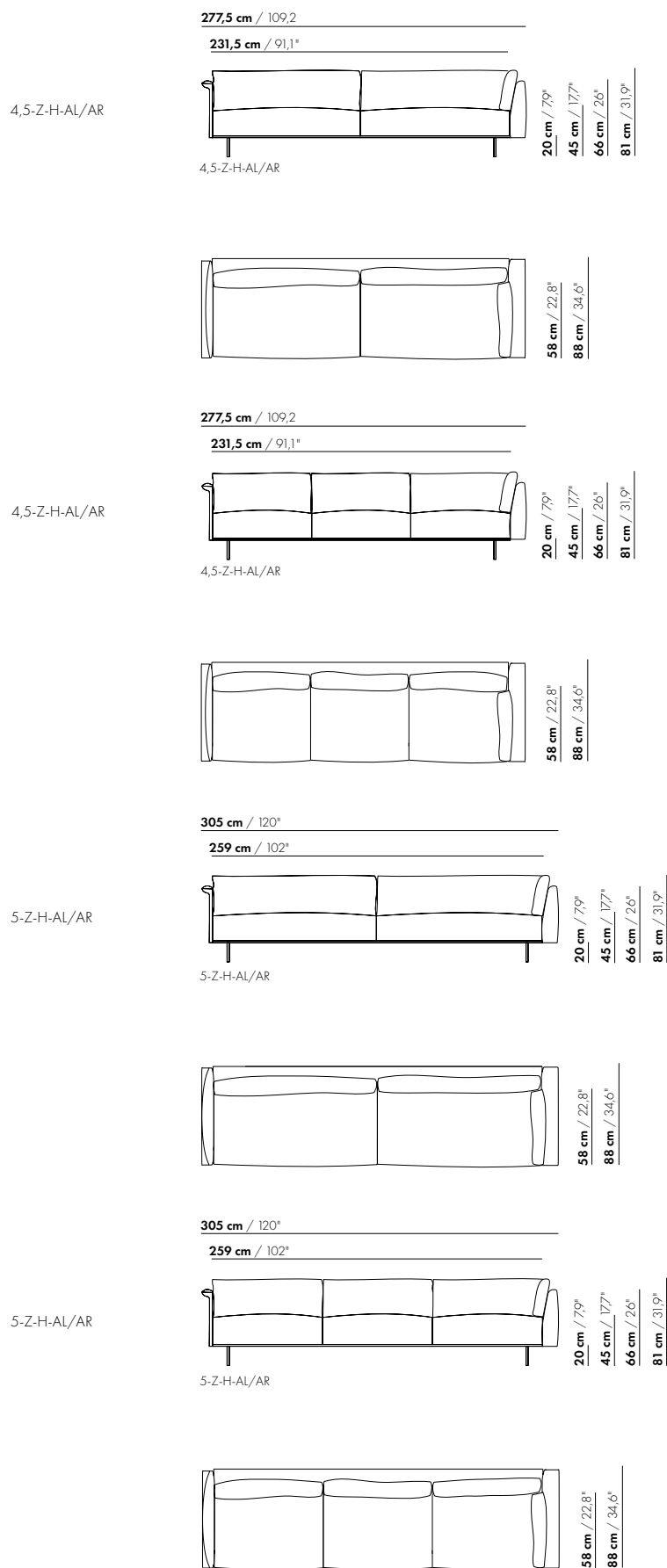

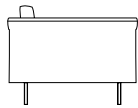

1,5-Z-XL

114,5 cm / 45°

82,5 cm / 32,5°

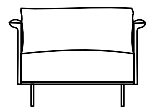

1,5-Z-XL

20 cm / 79°
45 cm / 177°
66 cm / 26°
81 cm / 31,9°

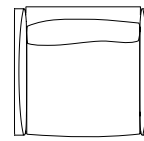

71 cm / 28°
101 cm / 39,7°

2-Z-XL

142 cm / 55,9°

110 cm / 43,3°

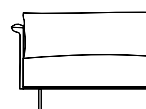

2-Z-XL

20 cm / 79°
45 cm / 177°
66 cm / 26°
81 cm / 31,9°

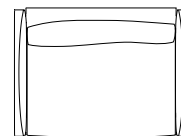

71 cm / 28°
101 cm / 39,7°

2,5-Z-XL

169,5 cm / 66,7°

137,5 cm / 54,1°



2,5-Z-XL

20 cm / 79°
45 cm / 177°
66 cm / 26°
81 cm / 31,9°

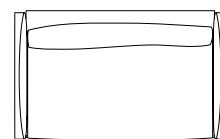

71 cm / 28°
101 cm / 39,7°

2,5-Z-XL

169,5 cm / 66,7°

137,5 cm / 54,1°

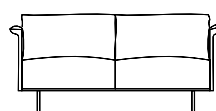

2,5-Z-XL

20 cm / 79°
45 cm / 177°
66 cm / 26°
81 cm / 31,9°

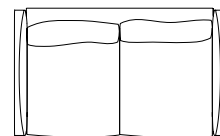

71 cm / 28°
101 cm / 39,7°

3-Z-XL

197 cm / 77,5°

165 cm / 65°

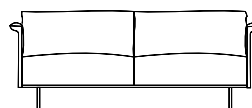

3-Z-XL

20 cm / 79°
45 cm / 177°
66 cm / 26°
81 cm / 31,9°

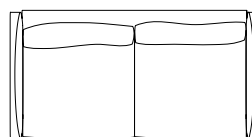

3-Z-XL

71 cm / 28°
101 cm / 39,7°

3,5-Z-XL

224,5 cm / 88,4°

192,5 cm / 75,8°

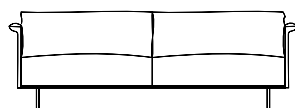

3,5-Z-XL

20 cm / 79°
45 cm / 177°
66 cm / 26°
81 cm / 31,9°

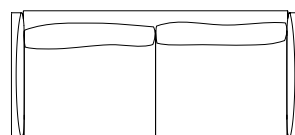

3,5-Z-XL

71 cm / 28°
101 cm / 39,7°

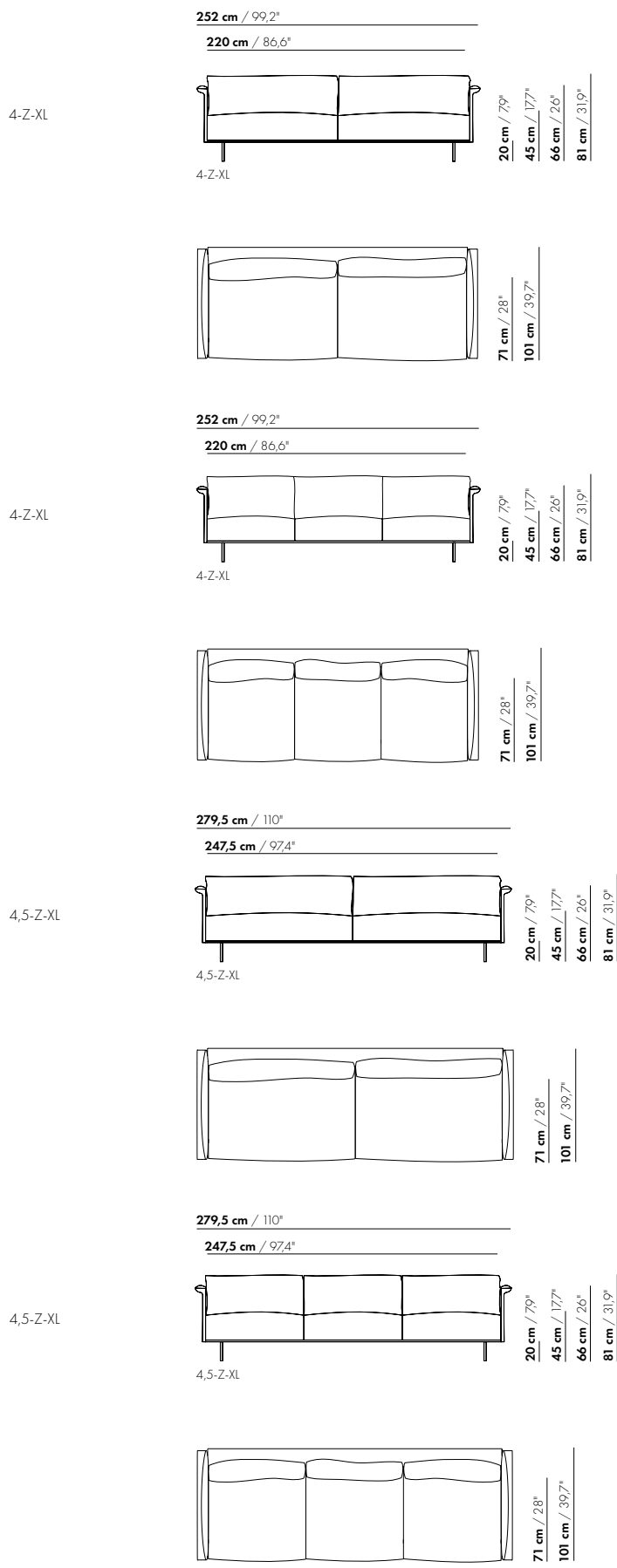

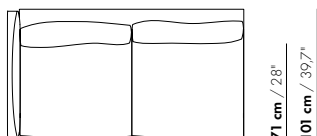
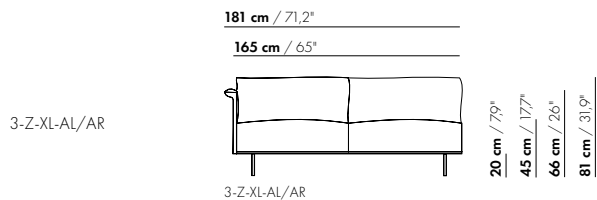
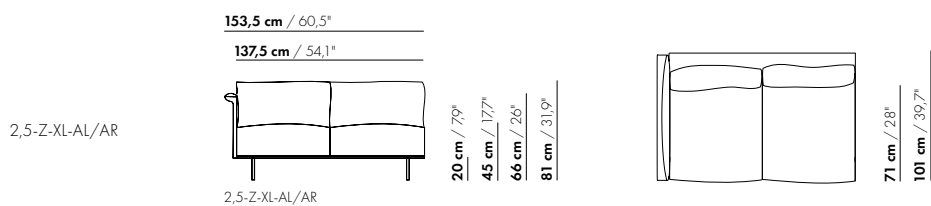
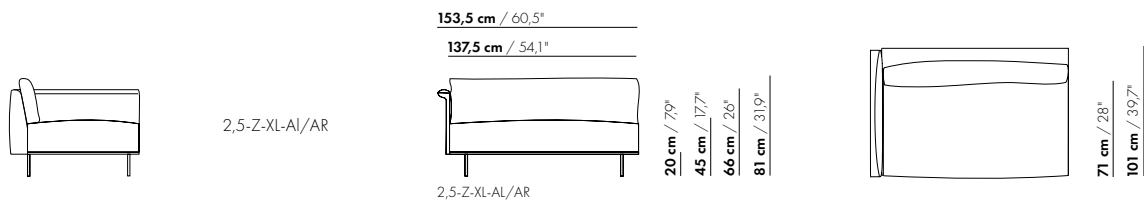
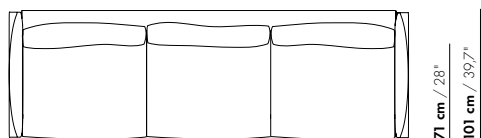
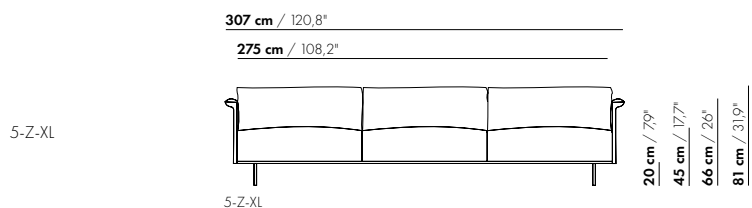
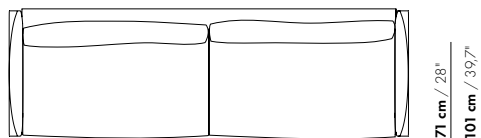
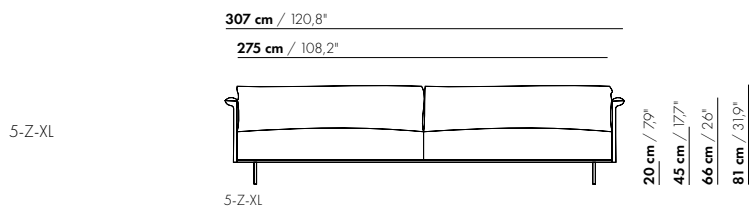

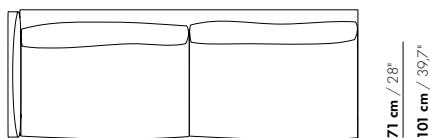
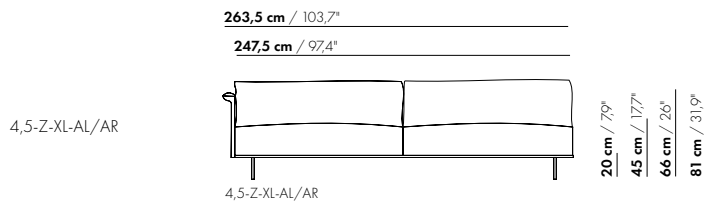
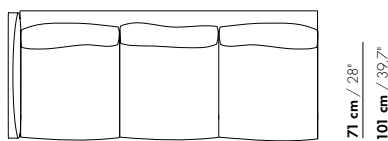
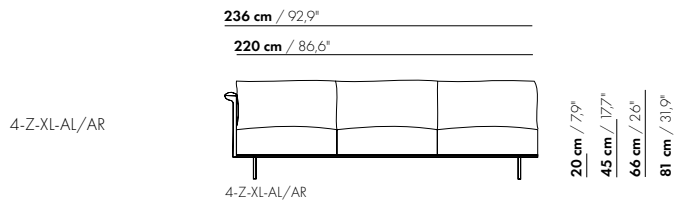
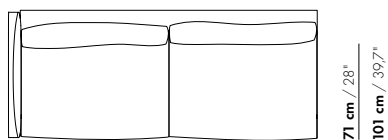
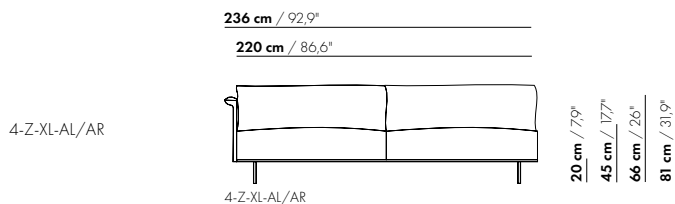
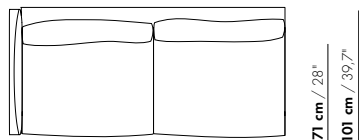
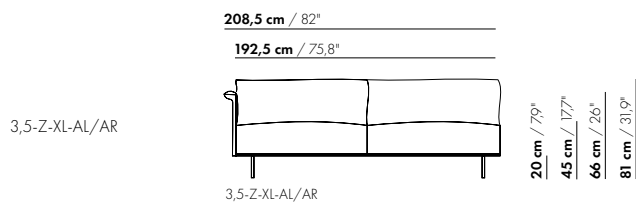

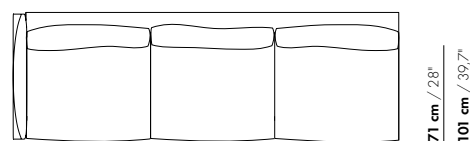
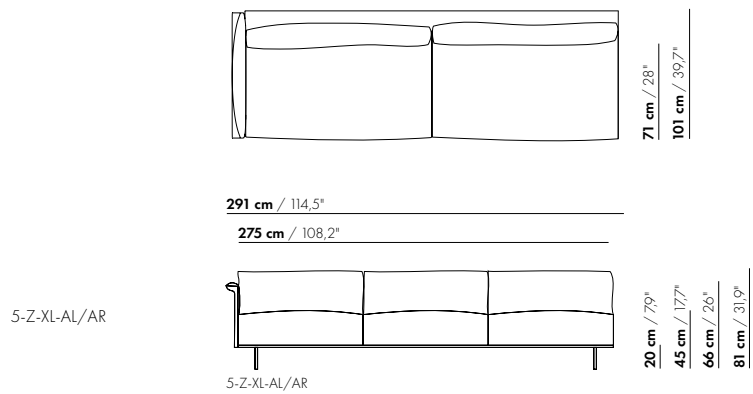
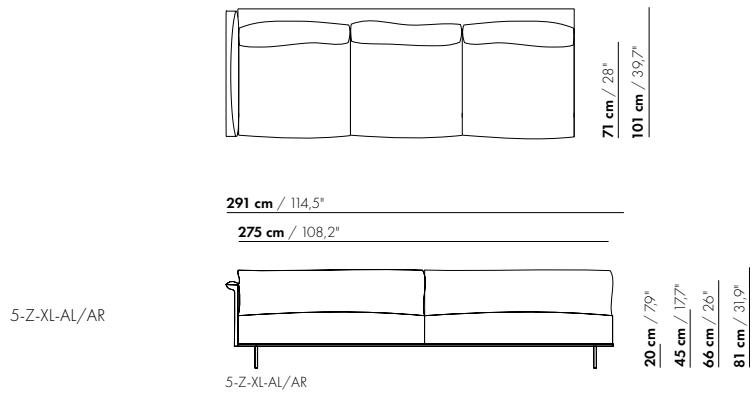
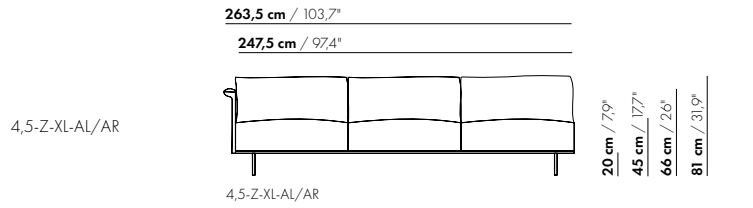

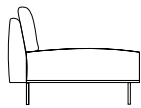

1,5-Z-XL-ZA

82,5 cm / 32,5"

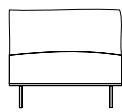

1,5-Z-XL-ZA

20 cm / 7,9"
45 cm / 17,7"
81 cm / 31,9"

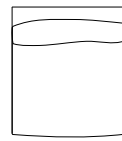

71 cm / 28"
101 cm / 39,7"

2-Z-XL-ZA

110 cm / 43,3"



2-Z-XL-ZA

20 cm / 7,9"
45 cm / 17,7"
81 cm / 31,9"

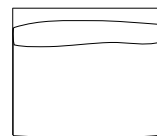

71 cm / 28"
101 cm / 39,7"

2,5-Z-XL-ZA

137,5 cm / 54,1"



2,5-Z-XL-ZA

20 cm / 7,9"
45 cm / 17,7"
81 cm / 31,9"

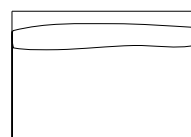

71 cm / 28"
101 cm / 39,7"

2,5-Z-XL-ZA

137,5 cm / 54,1"

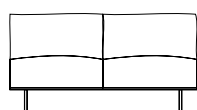

2,5-Z-XL-ZA

20 cm / 7,9"
45 cm / 17,7"
81 cm / 31,9"

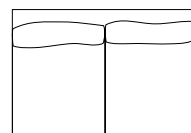

71 cm / 28"
101 cm / 39,7"

3-Z-XL-ZA

165 cm / 65"

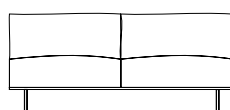

3-Z-XL-ZA

20 cm / 7,9"
45 cm / 17,7"
81 cm / 31,9"

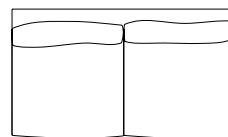

71 cm / 28"
101 cm / 39,7"



3,5-Z-D-XL-PL/PR

265,5 cm / 104,5"

176,5 cm / 69,5"

55 cm / 21,6"



3,5-Z-D-XL-PL/PR

20 cm / 7,9"
45 cm / 17,7"
66 cm / 26"
81 cm / 31,9"

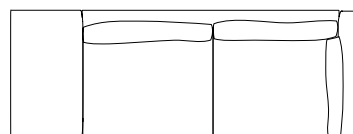

71 cm / 28"
101 cm / 39,7"

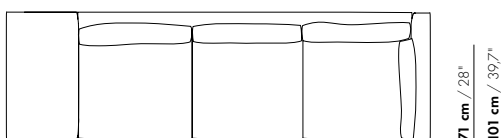
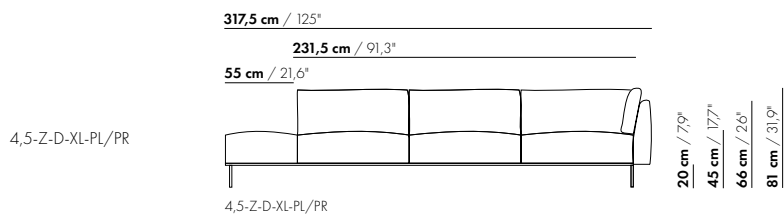
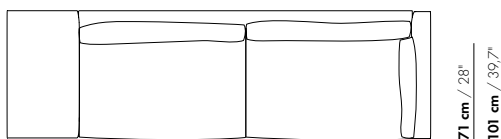
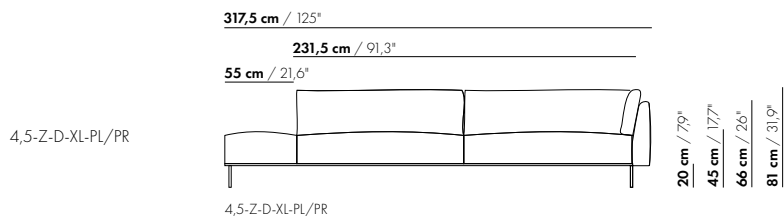
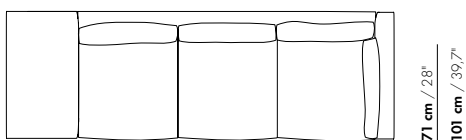
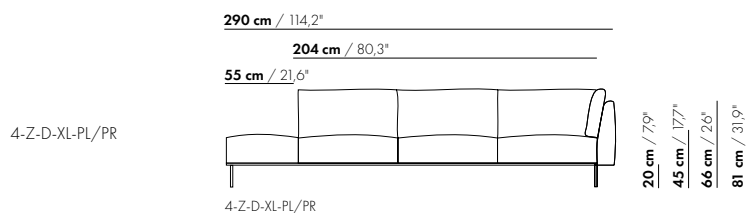
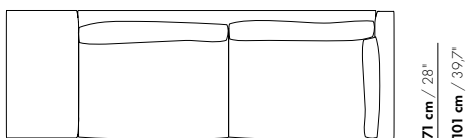
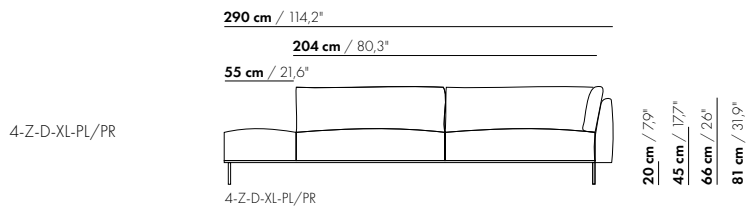

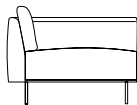

3-Z-H-XL-AL/AR

195 cm / 76,7"

149 cm / 58,6"

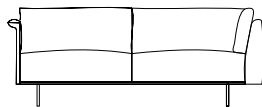

3-Z-H-XL-AL/AR

20 cm / 7,9"

45 cm / 17,7"

66 cm / 26"

81 cm / 31,9"

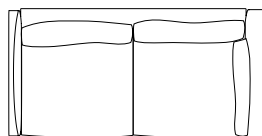

71 cm / 28"

101 cm / 39,7"

222,5 cm / 87,6"

176,5 cm / 69,5"

3,5-Z-H-XL-AL/AR

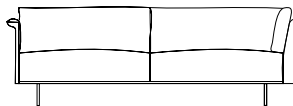

3,5-Z-H-XL-AL/AR

20 cm / 7,9"

45 cm / 17,7"

66 cm / 26"

81 cm / 31,9"

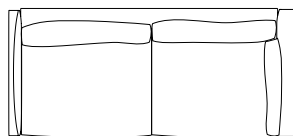

71 cm / 28"

101 cm / 39,7"

250 cm / 98,4"

204 cm / 80,3"

4-Z-H-XL-AL/AR

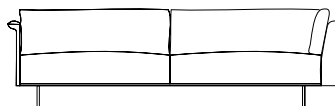

4-Z-H-XL-AL/AR

20 cm / 7,9"

45 cm / 17,7"

66 cm / 26"

81 cm / 31,9"

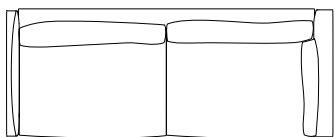

71 cm / 28"

101 cm / 39,7"

250 cm / 98,4"

204 cm / 80,3"

4-Z-H-XL-AL/AR

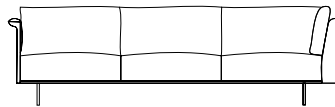

4-Z-H-XL-AL/AR

20 cm / 7,9"

45 cm / 17,7"

66 cm / 26"

81 cm / 31,9"

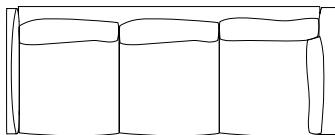

71 cm / 28"

101 cm / 39,7"

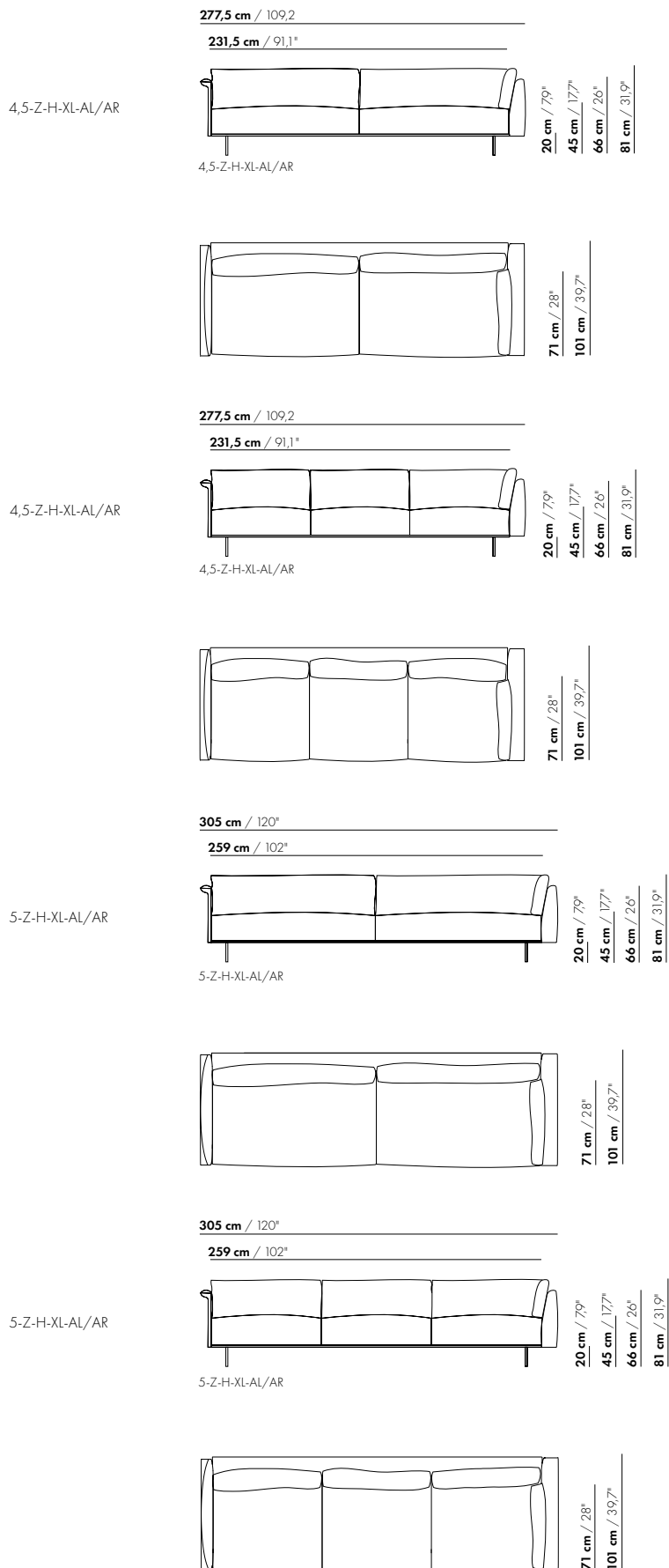

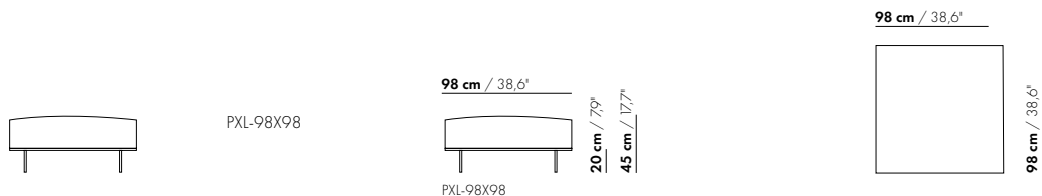
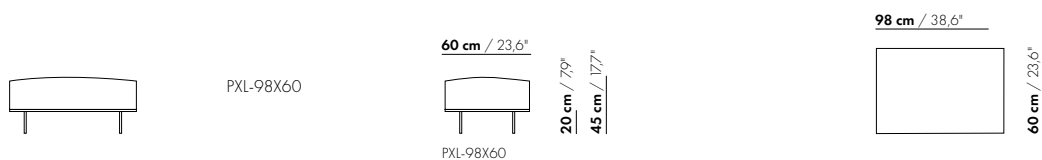
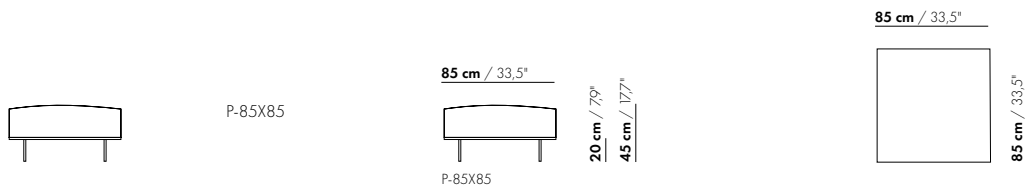
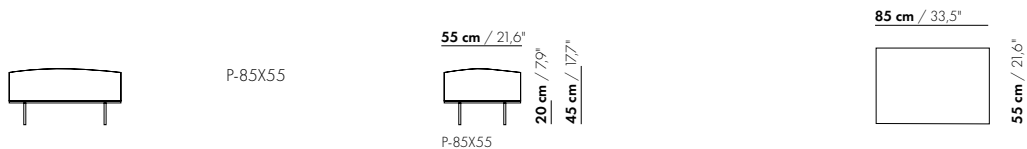
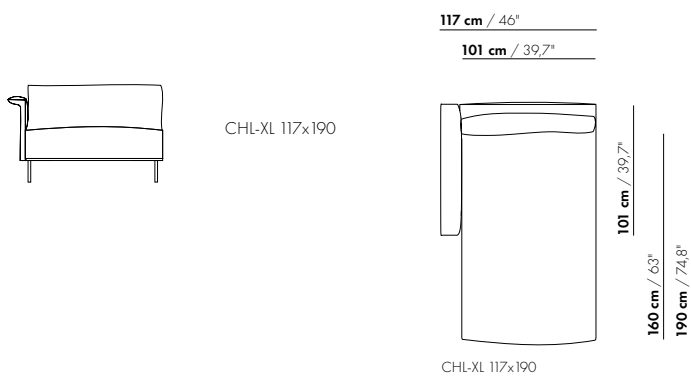
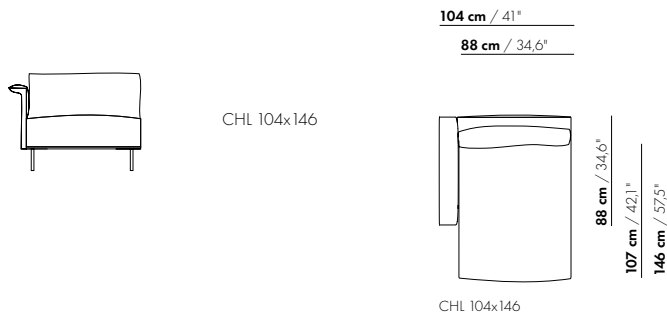

STANDARD
STITCHPATTERN LEATHER

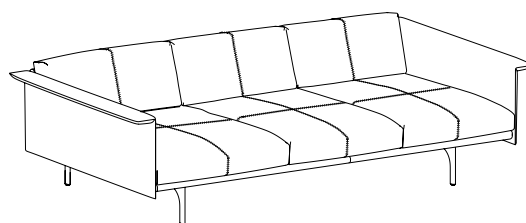

5-Z-3

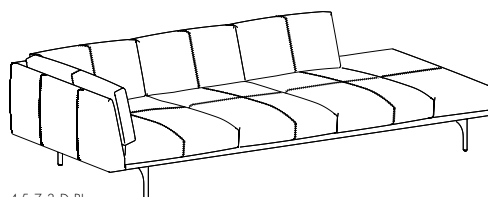

4,5-Z-3-D-PL

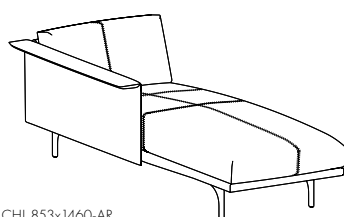

CHI 853x1460-AR