

# HEATH

2016 YABU PUSHELBERG



---

## DESIGN INSPIRATION

'Heath' is a series of tailored, curvilinear designs. Three unique seating elements combine into multiple sofa configurations. The armchair is available in two sizes, each with turned rustic wooden legs that extend up the sides of a tactile and comfortable, upholstered shell. And the coffee tables bring together two beautiful, natural materials—solid ash and pristine marble—in an interesting play between the geometric base and amorphous top. The result is stylish and sophisticated.



## DESIGNED BY YABU PUSHELBERG

It must have been fate. When George Yabu and Glenn Pushelberg graduated from Ryerson University in Toronto, both were looking for studio space. They decided to join forces and, in 1980, Yabu Pushelberg was born. Today, the firm has evolved into a globally renowned interior architecture and design practice, earning countless accolades along the way. From its studios in Toronto and New York, Yabu Pushelberg is probably best known for their high-end residential, hospitality and retail design. A lesser known fact may be that the company not only designs interiors, but also the furniture and objects that go along with them. Their pieces excel in an amazing attention to detail, with a tailored look that transcends any trend. As George Yabu puts it: 'There is a certain kind of design that burns very bright, but the flame goes out fast. We like to think our designs have more longevity, and a broader range of uses.'



## SPECIFICATIONS SEATING

**Body:** Metal frame, covered in injection-moulded flame-retardant polyurethane foam.

**Coupling system:** The elements in any configuration are joined together by a metal coupling system

**Legs armchair:** Solid ash

**Legs sofa:** wood stained black

**Seat cushions:** Polyurethane foam core in varying densities for optimum support and comfort, wrapped in a 100% cotton duvet filled with hypoallergenic polyester fibre.

**Back cushions:** Goose down and feathers with polyester fibre, or hypoallergenic polyester fibre only, 100% cotton inner cover.

**Upholstery:** Composition of fabrics depends on the customer's choice of upholstery. Leathers are either aniline or pigmented/sealed.

**Origin:** Hand made in Italy

## SPECIFICATIONS TABLE

**Legs:** Solid ash

**Tabletop:** Marble

**Origin:** Hand made in Italy

## OPTIONS SEATING

**Legs: Sofa:** stained black, standard height 4cm (not visible), 6 cm upon request. **Armchair:** stained olive green, charcoal grey or cream, protected by a matt varnish and with matching leather trim around the top of the legs. Nylon gliders, other gliders available upon request.

**Upholstery:** Removable cushion covers, fixed body cover, available in all fabrics and leathers from the LINTELOO collection. Customers can opt to supply their own choice of upholstery fabric/leather. Please note: leather upholstery of a sofa requires more (visible) seams than fabric upholstery. For an impression of LINTELOO's fabrics and leathers, see 'Materials' at [linteloo.com](http://linteloo.com)

**Cushions:** Back cushions available with either a goose down/feather or hypoallergenic fibre filling. For optimum versatility, all back cushions are ordered separately.

**Special features:** Full set of fabric replacement covers available at 50% of the current retail price of the piece of furniture. Leather replacement covers on request.

## OPTIONS TABLE

**Legs:** Stained olive green, charcoal grey, or cream, protected by a matt varnish.

**Marble top:** Zebrino, Cararra, Monaco or Graphite

## MAINTENANCE

All LINTELOO furniture has been made with love and care. Of course, we want you to enjoy it, for as long as possible. Proper maintenance will prolong its lifespan, which is why each piece of LINTELOO furniture comes with a maintenance instruction booklet, also available for download at [linteloo.com](http://linteloo.com) Detailed information on care and cleaning, including the recommended products, can also be found at [linteloo-care.nl](http://linteloo-care.nl)

**Upholstery:** Maintenance of the upholstery obviously depends on your choice of fabric or leather. As a rule of thumb, fabric upholstery—especially when removable—is easier to clean in case of spots and spills than leather. On the other hand, leather will handle regular wear and tear better, in a sense that the odd sign of use only adds to its character.

**Cushions:** Again, the level of maintenance depends on your choice of filling. Down/feather-filled cushions require regular plumping up and airing. But you may prefer the firmer seating experience and hypoallergenic qualities that a 100% polyester filling provides.

**Legs:** The occasional wipe-down with a damp cloth is all it takes.

**Natural stone:** Despite being treated with a stain-resistant product, natural stone remains susceptible to staining. We recommend that you regularly apply an impregnation agent.

## WARRANTY

All LINTELOO sofas and chairs are backed by a 10-year warranty on the frame. Cushions, upholstery and all other LINTELOO products are backed by a 3-year warranty, with a depreciation of 1/3 each year. Please make sure you keep your invoice or receipt. Excluded from the warranty are:

- Regular wear and tear, damages and discolouration of upholstery (fabric and/or leather).
- Creasing, colour and structure variations and other irregularities, which are part of the natural characteristics of fabrics, leather and/or wood.
- Complaints regarding fabrics and/or leathers which are not part of the standard LINTELOO collection (specially supplied fabrics and/or leathers).
- Damages caused by improper use, inadequate or incorrect maintenance, or repairs carried out outside the scope of LINTELOO's responsibility. LINTELOO uses the Terms and Conditions of the Centrale Bond van Meubelfabrikanten, available at [www.linteloo.com](http://www.linteloo.com).

If you have any questions, please contact your LINTELOO dealer or LINTELOO's customer service department.



## DIMENSIONS



**armchair 87 x 77**  
4,00

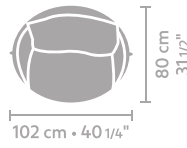

**armchair 102 x 80**  
4,40

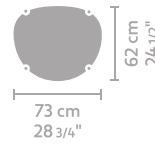

**coffee table 73 x 62**

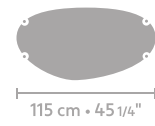

**coffee table 115 x 60**



metrage

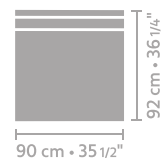

**central element 90 x 92**  
5,00

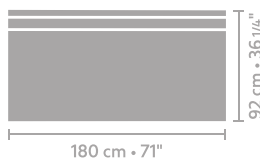

**central element 180 x 92**  
10,2

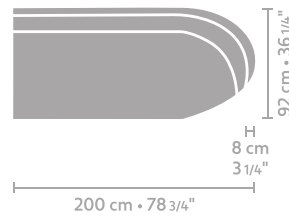

**element 200 x 92**  
9,10



metrage

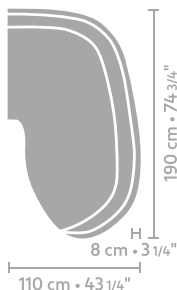

**longchair arm L/R**  
9,40

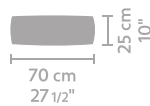

**throw pillow 70 x 25**  
0,90

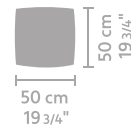

**throw pillow 50 x 50**  
0,70

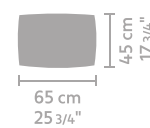

**throw pillow 65 x 45**  
0,90

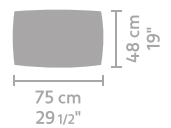

**throw pillow 75 x 48**  
1,20

metrage

## CONFIGURATION 1

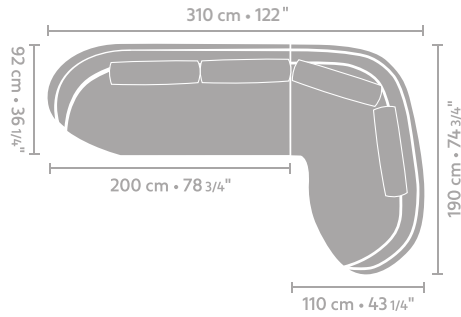

- Element 200x92
- Longchair arm R
- 4x throw pillow 75x48

## CONFIGURATION 2

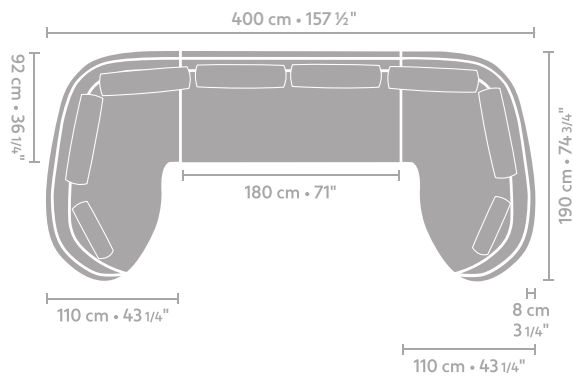

- Longchair arm L
- Longchair arm R
- Central element 180x92
- 6x throw pillow 75x48
- 2x throw pillow 50x50

## CONFIGURATION 3

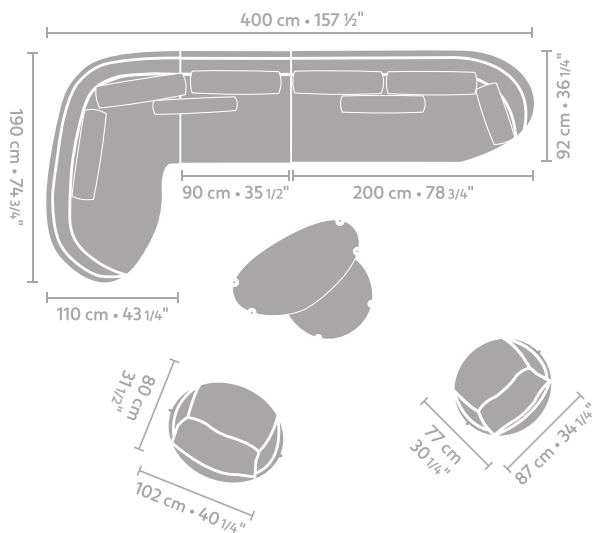

- Longchair arm L
- Central element 90x92
- 5x throw pillow 75x48
- 2x throw pillow 70x28
- Throw pillow 65x45
- Heath coffee table 73x62
- Heath coffee table 115x60
- Armchair 87x77
- Armchair 102x80