

TECHNISCHE GEGEVENEN

ROLF BENZ 318 LINEA



**ROLF
BENZ**

- Houten binnenromp
- Nosag veren
- Bekleding onderzijde, met polyestervlies
- Rug van polyurethaanschuim

Classic:

- Zitting van polyurethaanschuim, gelaagde opbouw, met verschillende hoogtes en uitvoeringen op elkaar afgestemd

Lounge plus:

- Zitting van hoogwaardig koudschuim
- Poten naar keuze:
 - Spang roestvrij staal
 - Spang gelakt in verkeerszwart RAL 9017

Kegelpoot naar keuze

- Poot eiken H70
- Poot eiken H98
- Poot notenhout H81

Classic

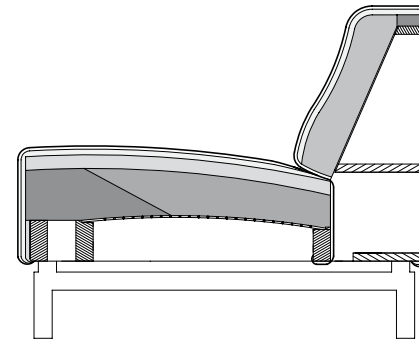

Lounge plus

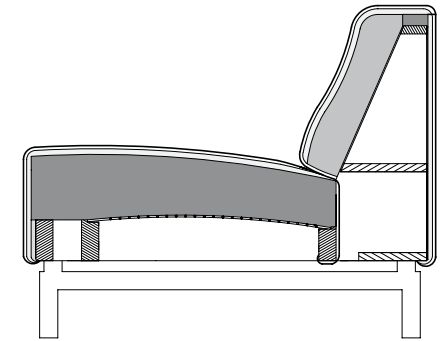

Zithoogtes leverbaar

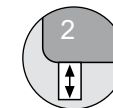

- ! Ploovorming en zitafdrucken zijn vanwege comfort- en designredenen ook bij hoogwaardige gestoffeerde meubels van Rolf Benz niet te vermijden. Alle afmetingen zijn bij benadering.

**ROLF
BENZ**

Fauteuil

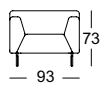

Bank

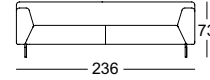
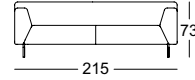
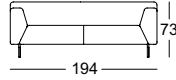
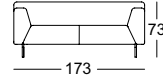
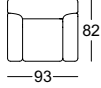

Aanbouwbank*

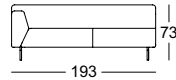
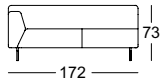

Eindelement met gestofferde zitting*

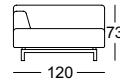
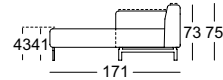

Hoek-Aanbouwbank

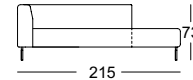

Voetenbank groot

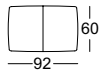

Voetenbankje



Rugkussen

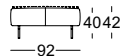

Combinatie voorbeelden:

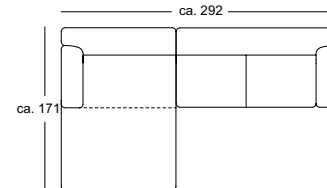

ASS-PSZ 318/120 li.
ASO 318/172 re.

*Deze elementen zijn als linker uitvoering afgebeeld, ze zijn echter ook in spiegelbeeld, in de rechter uitvoering leverbaar.